

SPICE thermal model

BUK9Y3R0-40E

Symbol	Parameter	Conditions	Min	Typ	Max	Unit
$R_{th(j-mb)}$	thermal resistance from junction to mounting base		-	-	0.77	K/W

C_{th1}	6.162E-05 F
C_{th2}	4.070E-04 F
C_{th3}	4.396E-04 F
C_{th4}	3.634E-03 F
C_{th5}	6.243E-03 F
C_{th6}	1.557E-02 F
C_{th7}	1.939E-01 F
R_{th1}	1.359E-03 Ω
R_{th2}	2.443E-03 Ω
R_{th3}	1.954E-02 Ω
R_{th4}	2.996E-02 Ω
R_{th5}	1.383E-01 Ω
R_{th6}	5.185E-01 Ω
R_{th7}	6.149E-02 Ω

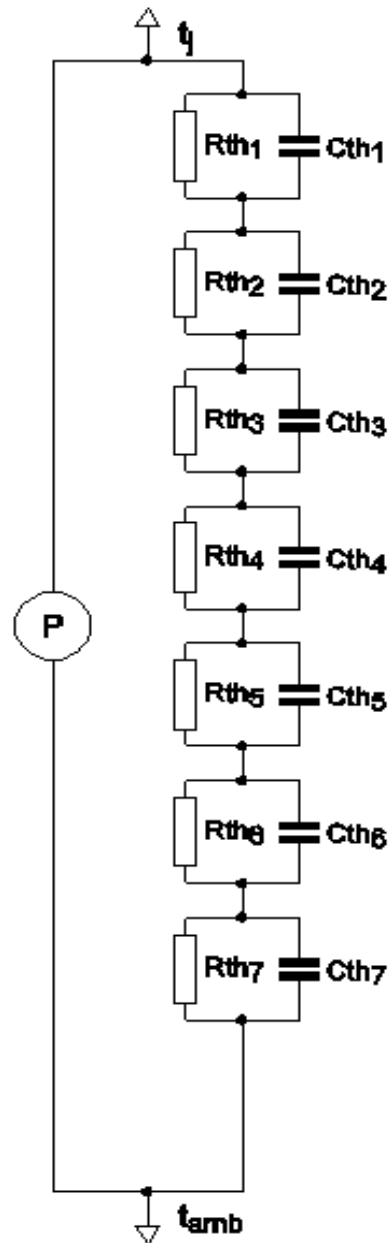

Part: BUK9Y3R0-40E
 Date: 25/1/2013
 Rth 0.77 K/W